

AM/FM STEREO RECEIVER

KR-A5520

INSTRUCTION MANUAL

KENWOOD CORPORATION

KENWOOD

Introduction

Your choice of this product indicates that you are a devotee to excellence in sound reproduction.

We appreciate your patronage and take pride in the long tradition of quality components that our company represents.

So that you can get the most out of your unit, we suggest that you take the time to read through this manual before you hook up and operate your system. This will acquaint you with operating features and system-connection considerations so that your listening pleasure will be enhanced right from the start. You will notice that in all aspects of planning, engineering, styling, operating convenience and adaptability we have sought to anticipate your needs and desires.

Keep this manual handy for future reference.

For your records

Record the serial number, found on the back of the unit, in the spaces designated on the warranty card, and in the space provided below. Refer to the model and serial numbers whenever you call upon your dealer for information or service on this product.

Model _____ Serial Number _____

Unpacking

Unpack the unit carefully and make sure that all accessories are put aside so they will not be lost.

Examine the unit for any possibility of shipping damage. If your unit is damaged or fails to operate, notify your dealer immediately. If your unit was shipped to you directly, notify the shipping company without delay. Only the consignee (the person or company receiving the unit) can file a claim against the carrier for shipping damage.

We recommend that you retain the original carton and packing materials for use should you transport or ship the unit in the future.

For the USA

Note to CATV system installer:

This reminder is provided to call the CATV system installer's attention to Article 820-22 of the NEC that provides guidelines for proper grounding and, in particular, specifies that the cable ground shall be connected to the grounding system of the building, as close to the point of cable entry as practical.

Accessories

FM indoor antenna 1 AM loop antenna..... 1

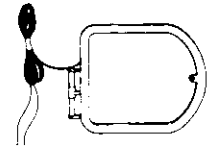

Batteries ("AA" or "R6") 2

Loop antenna holder 1



Remote control unit 1

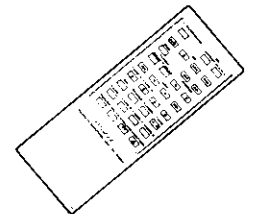

Contents

Caution: Read the pages marked  carefully to ensure safe operation.

Introduction	2	Controls and indicators	10
▲ Before applying power	3	Operating instructions	12
▲ Safety precautions	3	Listening to broadcasts	14
▲ IMPORTANT SAFEGUARDS	4	Remote control.....	16
System connections	6	System control operation	19
Speaker connections	7	In case of difficulty	20
Antenna connections.....	8	Specifications.....	21
FM DE-EMPHASIS/CHANNEL SPACE switch.....	9		

Before applying power

For the U.S.A. and Canada

Important!

Units shipped to the U.S.A. and Canada are designed for operation on 120 volts AC only

Safety precaution for a Polarized AC plug

However, some products may be supplied with a non-polarized plug

CAUTION: TO PREVENT ELECTRIC SHOCK DO NOT USE THIS (POLARIZED) PLUG WITH AN EXTENSION CORD, RECEPTACLE OR OTHER OUTLET UNLESS THE BLADES CAN BE FULLY INSERTED TO PREVENT BLADE EXPOSURE

For the United Kingdom

Important!

Units shipped to the U.K. are designed for operation on 240 volts AC only.

The mains plug must be removed from the wall socket prior to any internal examination

The wires in this mains lead are coloured in accordance with the following code:

Blue Neutral
Brown Live

The wires in this mains lead must be connected to the terminals in the plug as follows:

Wire colour	Plug terminal marking
Blue	N or Black
Brown	L or Red

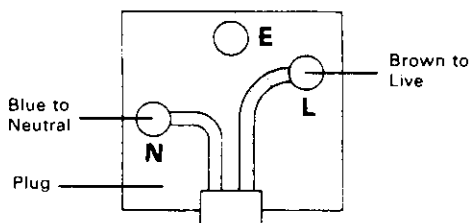

- Notes:**
1. If a 13-amp plug is used, this must be fitted with a 5-amp fuse.
 2. If a 3-pin plug with earthing contact is used, no wire must be connected to the E terminal

For Australia and Europe

Important!

Units shipped to Australia are designed for operation on 240 V AC only.

Units shipped to Europe are designed for operation on 220 V AC only

For other countries

Important!

Units shipped to countries other than the above countries are equipped with an AC voltage selector switch on the rear panel. Refer to the following paragraph for the proper setting of this switch.

AC voltage selection

This unit operates on 110-120 or 220-240 volts AC. The AC voltage selector switch Type A or Type B on the rear panel is set to the voltage that prevails in the area to which the unit is shipped. Before connecting the power cord to your AC outlet, make sure that the setting position of this switch matches your line voltage. If not, it must be set to your voltage in accordance with the following direction.

Note: Our warranty does not cover damage caused by excessive line voltage due to improper setting of the AC voltage selector switch.

AC voltage selector switch

Type A

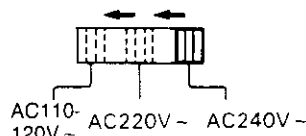

Type B

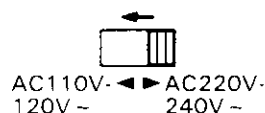

Move switch lever to match your line voltage with a small screwdriver or other pointed tool.

Safety precautions

WARNING: TO PREVENT FIRE OR SHOCK HAZARD, DO NOT EXPOSE THIS APPLIANCE TO RAIN OR MOISTURE.



CAUTION
RISK OF ELECTRIC SHOCK
DO NOT OPEN



CAUTION: TO REDUCE THE RISK OF ELECTRIC SHOCK, DO NOT REMOVE COVER (OR BACK). NO USER-SERVICEABLE PARTS INSIDE, REFER SERVICING TO QUALIFIED SERVICE PERSONNEL.



THE LIGHTNING FLASH WITH ARROWHEAD SYMBOL, WITHIN AN EQUILATERAL TRIANGLE, IS INTENDED TO ALERT THE USER TO THE PRESENCE OF UNINSULATED "DANGEROUS VOLTAGE" WITHIN THE PRODUCT'S ENCLOSURE THAT MAY BE OF SUFFICIENT MAGNITUDE TO CONSTITUTE A RISK OF ELECTRIC SHOCK TO PERSONS.



THE EXCLAMATION POINT WITHIN AN EQUILATERAL TRIANGLE IS INTENDED TO ALERT THE USER TO THE PRESENCE OF IMPORTANT OPERATING AND MAINTENANCE (SERVICING) INSTRUCTIONS IN THE LITERATURE ACCOMPANYING THE APPLIANCE.

IMPORTANT SAFEGUARDS

⚠ Caution : Read this page carefully to ensure safe operation.

Please read all of the safety and operating instructions before operating this unit. For best results, follow all warnings placed on the unit and adhere to the operating and use instructions. These safety and operating instructions should be retained for future reference.

1. Power sources — The unit should be connected to a power supply only of the type described in the operating instructions or as marked on the appliance.

2. Power-cord protection — Power-supply cords should be routed so that they are not likely to be walked on or pinched by items placed upon or against them, pay particular attention to cords at plugs, convenience receptacles, and the point where they exit from the unit.

Never pull or stretch the cord.



3. Grounding or polarization — The precautions should be taken so that the grounding or polarization means of this unit is not defeated.

4. Ventilation — The unit should be situated so that its location or position does not interfere with its proper ventilation.

To maintain good ventilation, do not put records or a table-cloth on the unit. Place the unit at least 10 cm away from the walls.

Do not use the unit on a bed, sofa, rug or similar surface that may block the ventilation openings.

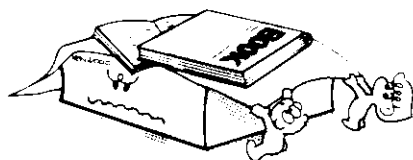

5. Water and moisture — The unit should not be used near water — for example, near a bathtub, washbowl, kitchen sink, laundry tub, in a wet basement, or near a swimming pool, etc.

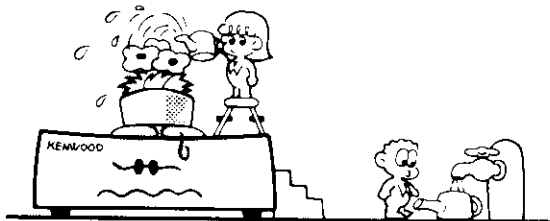

6. Temperature — The unit may not function properly if used at extremely low, or freezing temperatures. The ideal ambient temperature is above +5°C (41°F).

7. Heat — The unit should be situated away from heat sources such as radiators, heat registers, stoves, or other units (including amplifiers) that produce heat.

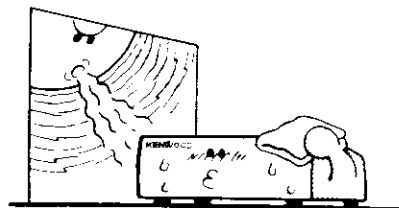

8. Electric shock — Care should be taken so that objects do not fall and liquid is not spilled into the enclosure through openings. If a metal object, such as a hair pin or a needle, comes into contact with the inside of this unit, a dangerous electric shock may result. For families with children, never permit children to put anything, especially metal, inside this unit.

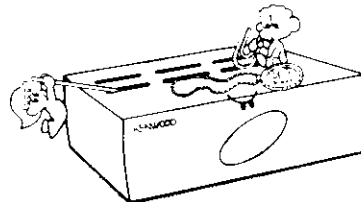

9. Enclosure removal — Never remove the enclosure. If the internal parts are touched accidentally, a serious electric shock might occur.

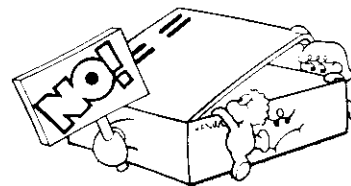

10. Magnetic fields — Keep the unit away from sources of magnetic fields such as TV sets, speaker systems, radios, motorized toys or magnetized objects.

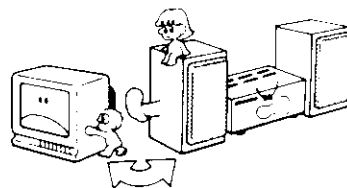

11. Cleaning — Do not use volatile solvents such as alcohol, paint thinner, gasoline, or benzine, etc. to clean the cabinet. Use a clean dry cloth.



12. Carts and stands — An appliance and cart combination should be moved with care. Quick stops, excessive force, and uneven surfaces may cause the appliance and cart combination to overturn.



13. Nonuse periods — The power cord of the unit should be unplugged from the outlet when left unused for a long period of time.

14. Abnormal smell — If an abnormal smell or smoke is detected, immediately turn the power OFF and pull out the power cord. Contact your dealer or nearest service center.

POWER OFF!

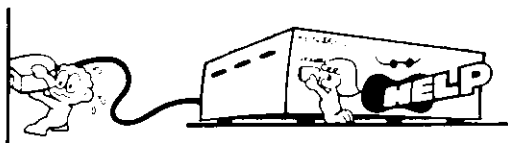

15. Damage requiring service — The unit should be serviced by qualified service personnel when:

- A.** The power-supply cord or the plug has been damaged; or
- B.** Objects have fallen, or liquid has been spilled into the unit; or
- C.** The unit has been exposed to rain; or
- D.** The unit does not appear to operate normally or exhibits a marked change in performance; or
- E.** The unit has been dropped, or the enclosure damaged.

16. Servicing — The user should not attempt to service the unit beyond that described in the operating instructions. All other servicing should be referred to qualified service personnel.

17. Outdoor antenna grounding — If an outside antenna is connected to the receiver, be sure the antenna system is grounded so as to provide some protection against voltage surges and built up static charges. Section 810 of the National Electrical Code, ANSI/ NFPA No. 70—1984, provides information with respect to proper grounding of the mast and supporting structure, grounding of the lead-in wire to an antenna discharge unit, size of grounding con-

ductors, location of antenna-discharge unit, connection to grounding electrodes, and requirements for the grounding electrode. See Figure.

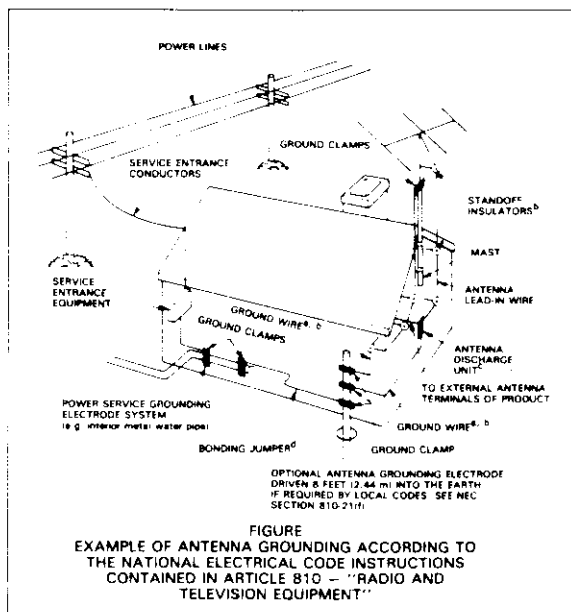

^a Use No. 10 AWG (5.3 mm²) copper, No. 8 AWG (8.4 mm²) aluminum, No. 17 AWG (1.0 mm²) copper-clad steel or bronze wire, or larger, as a ground wire

^b Secure antenna lead-in and ground wires to house with stand-off insulators spaced from 4 — 6 feet (1.22 — 1.83 m) apart.

^c Mount antenna discharge unit as close as possible to where lead-in enters house

^d Use jumper wire not smaller than No. 6 AWG (13.3 mm²) copper, or the equivalent, when a separate antenna-grounding electrode is used See NEC Section 810-21(f)

18. Power lines — An outdoor antenna should be located away from power lines.

19. AC outlets — Do not connect other audio equipment with a power consumption larger than that specified to the AC outlet on the rear panel. Never connect other electrical units, such as an iron or toaster, to it to prevent fire or electric shock.

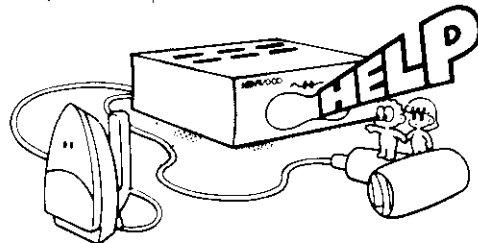

The maximum capacities indicated for the AC outlets on the rear panel of this unit are as follows.

SWITCHED outlets ; 200 W

- Notes:**
1. Item 3 is not required except for grounded or polarized equipment.
 2. Item 17 and 18 are not required except for units provided with antenna terminals.
 3. Item 17 complies with UL-1270 in the U.S.A.

System connections

Make connections as shown in the diagram below.

When connecting the related system components, refer also to the instruction manuals of the related components.

Do not plug in the power lead until all connections are complete.

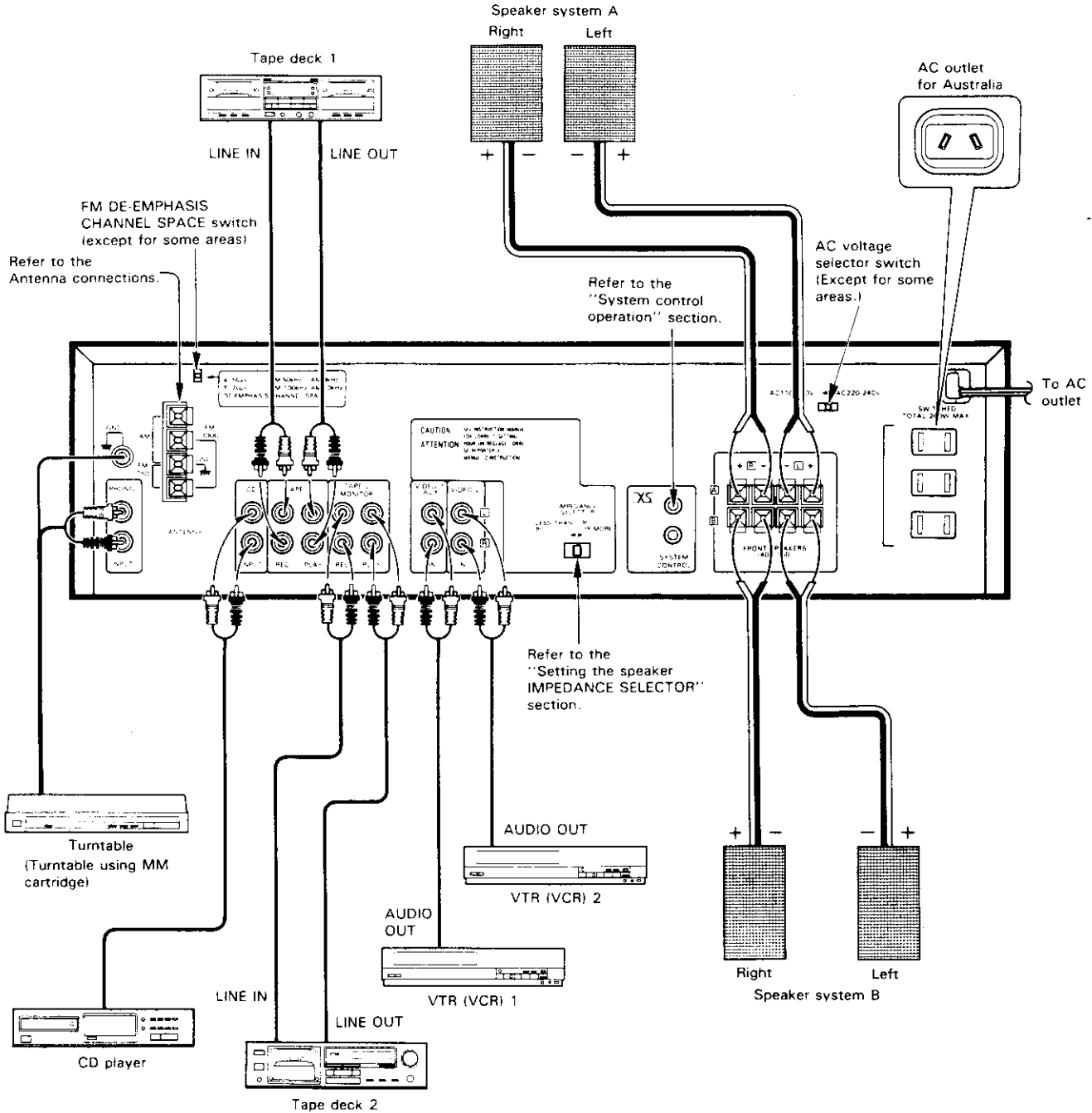

Notes:

1. To prevent possible problems, always disconnect the power plug or turn off the POWER switch of the receiver before connecting or disconnecting the audio cables.
2. When connecting audio cables, always insert the pin plugs securely into the connecting jacks.
 - Insufficient insertion may result in no-sound problems or generation of noise.

Speaker connections

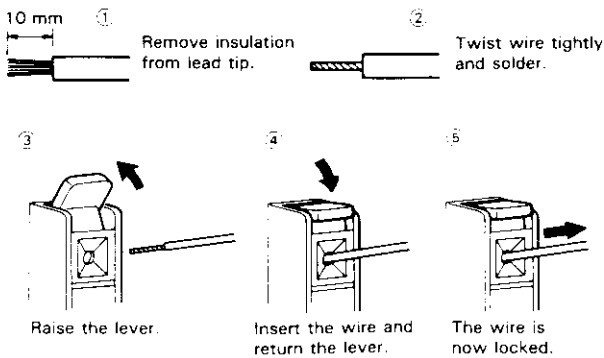

Speaker lead connection

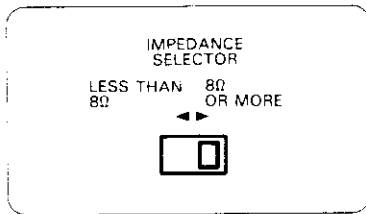

■ Connecting the speakers

Connect speakers rated at 4 ohm or more to the SPEAKERS terminals.

1. Connect the left speaker to the L speaker terminals on the rear of the receiver and the right speaker to the R terminals.
2. Connect each cable as shown in the illustration, taking care that the wires do not make contact with other terminals.

Notes:

1. Take care so as not to short the positive (+) and negative (-) speaker cords.
2. If the left and right speakers, or positive and negative cables, are connected the wrong way, the reproduced sound may be unclear, with ambiguous location of the musical instruments etc. To avoid this, pay attention to the left and right and positive and negative indications when connecting the speakers.

■ Setting the speaker IMPEDANCE SELECTOR

When connecting one pair of speakers to the SPEAKERS A or B terminals, set the IMPEDANCE SELECTOR according to the speaker impedance.

When two pairs of speakers are connected to both the A and B terminals, match the speaker impedance selector to the speakers with the lowest impedance.

Notes:

1. During speaker system connection and operation of the speaker IMPEDANCE SELECTOR, set the POWER switch to OFF.
2. Check that the connected lead wires of the speaker systems do not contact with other jacks or terminals.

Speaker impedance	Selector position	
4Ω, 6Ω	LESS THAN 8Ω	
8Ω, 16Ω	8Ω OR MORE	

■ AC outlets

The AC outlets on the rear panel may be used to supply power to other components in the system, such as turntables, tape decks, etc. Never connect equipment whose power consumption exceeds the maximum value shown at each outlet. (In Europe, do not connect a main amplifier or similar components to any of the AC outlets.)

SWITCHED outlets:

These outlets supply power only when the unit is turned on. The maximum total capacity is 200 watts.

WARNING

Particular attention must be given to making good electrical contact at the receiver output and speaker terminals.

Poor or loose connections can cause sparking or burning at the terminals because of the very high power that the receiver can deliver.

Antenna connections

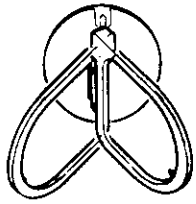

Vary the direction of the loop antenna.

AM loop antenna

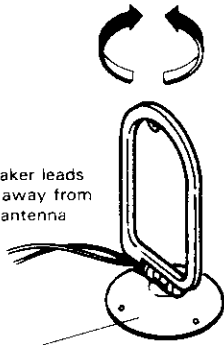

Keep the speaker leads and AC cord away from the AM loop antenna

AM loop antenna holder

AM outdoor antenna

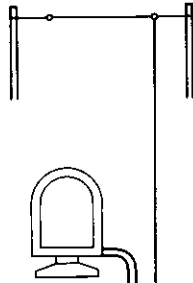

AM loop antenna

FM indoor antenna FM outdoor antenna

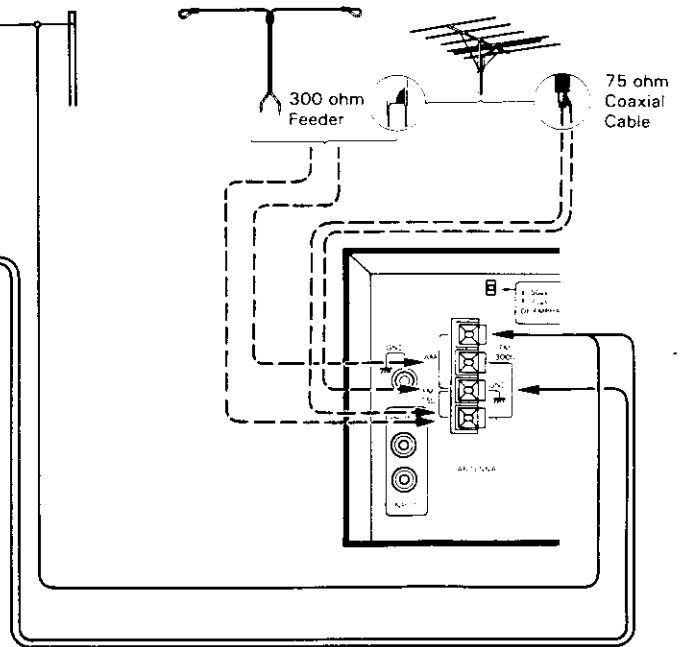

■ AM antennas

AM loop antenna

Attach the AM loop antenna to the supplied loop antenna stand and place it on a shelf, etc., or install it on the rack or wall with screws.

Rotate the AM loop antenna to the right or left for best reception.

Note:

Do not place the AM loop antenna directly on the unit. As this unit employs computing devices, placing the AM loop antenna on the unit may result in noise generation. Place the AM loop antenna away from the unit.

AM outdoor antenna

In steel buildings or at a great distance from the transmitter, it may be necessary to install an outside long wire antenna. The end of this wire should be stripped of insulation and connected to the AM terminal. At this time, keep the loop antenna connected.

■ FM antennas

FM indoor antenna

Connect the T-shaped indoor antenna (supplied) to the 300 ohm FM ANTENNA terminals. Spread the two arms that from the top of the "T" horizontally and hold them against convenient wall surfaces. Try several locations for best results with frequently listened to stations. Tape the antenna in place where the best compromise is found between listening results and appearance.

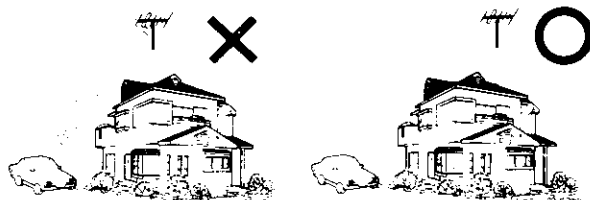

- To minimize auto-ignition noise, locate the antenna as far from heavy traffic as possible.
- Keep the feeder or coaxial cable as short as possible. Do not bundle or roll up excess cable.
- The antenna should be at least two meters (6.6 feet) from reinforced concrete walls or metal structures.

FM outdoor antenna setting

FM outdoor antenna

Be sure to use an outdoor FM antenna to receive good sound quality FM broadcasts with a minimum of noise. When connecting an outdoor antenna to the antenna terminals of this unit, connect as illustrated.

Note:

An FM outdoor antenna can be connected to the tuner with either a 75 ohm coaxial cable or a 300 ohm ribbon feeder. For proper connection, carefully read the instruction manual for the FM outdoor antenna.

■ 75 ohm coaxial cable connection

If your FM antenna uses a 75 ohm coaxial cable, prepare the end of the cable as shown in Fig. 1, and connect it to the antenna terminals on the rear panel as shown in Fig. 2.

(Figure. 1)



(Figure. 2)

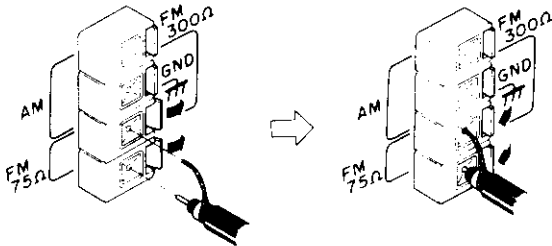

Area	Channel Space Frq.	FM DE-EMPHASIS
1. U.S.A., Canada and South American countries	FM: 100 kHz	75 μ s
	AM: 10 kHz	
2. Other countries	FM: 50 kHz	50 μ s
	AM: 9 kHz	

FM DE-EMPHASIS/CHANNEL SPACE table

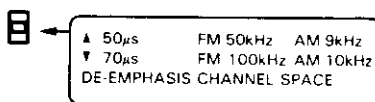

■ FM DE-EMPHASIS/CHANNEL SPACE switch (Except for some areas)

The FM DE-EMPHASIS/CHANNEL SPACE switch on the rear panel is set to the correct setting that prevails in the area to which the unit is shipped. However, if the FM DE-EMPHASIS/CHANNEL SPACE setting is not matched to the area where the unit is to be used for instance, when you move from area 1 to area 2 or vice versa, desired reception of AM/FM broadcasts cannot be expected. In this case, change the FM DE-EMPHASIS/CHANNEL SPACE setting in accordance with the area corresponding to the table on the left.

The FM DE-EMPHASIS setting is switched over at the same time.

Note:

When changing the setting of the FM DE-EMPHASIS/CHANNEL SPACE switch, first disconnect the power cord, then reset the channel space switch, connect the power cord again, and turn the power on.

Controls and indicators

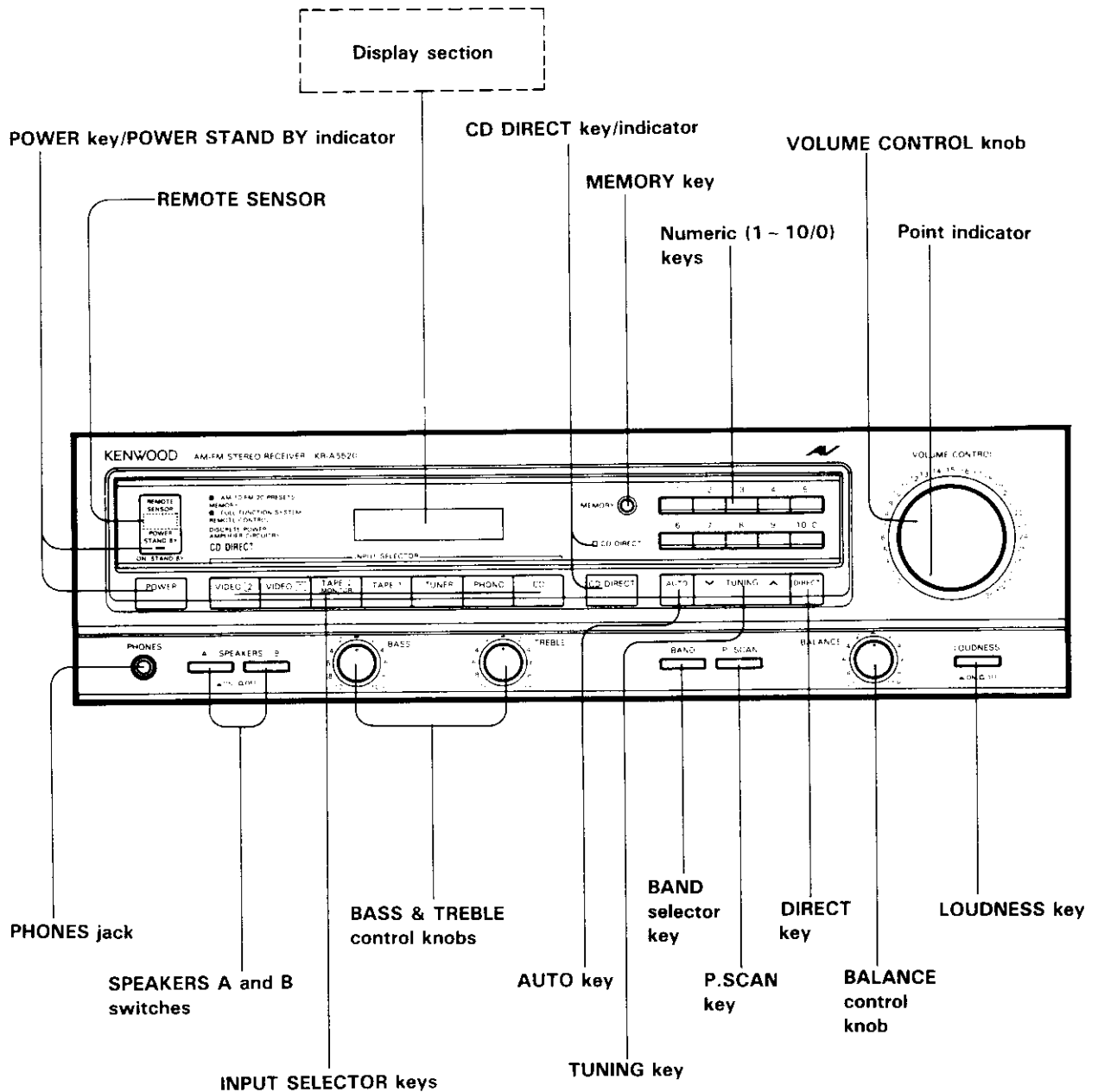

SPEAKERS A and B switches

- A, B OFF** — This position silences all speakers to permit private use of headphones.
- A ON** — Activates speakers connected to the SPEAKERS A terminals on the rear panel.
- B ON** — Activates the speakers connected to the SPEAKERS B terminals on the rear panel.
- A, B ON** — Activates the speakers connected to the SPEAKERS A and B terminals simultaneously.

Note:

When the SPEAKERS A and B switches are both pressed ON, the speakers connected to the SPEAKERS A and B terminals are connected in series. Therefore, when using the SPEAKERS A and B switches at the same time, be sure that two pairs of speakers are connected to the terminals A and B, otherwise no sound is output.

Display section

AUTO indicator

TUNED indicator

STEREO indicator

MEMORY indicator

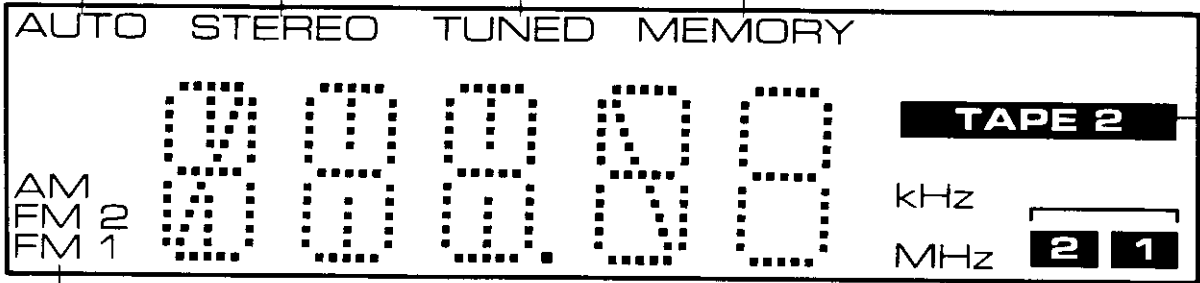

AM
FM 2
FM 1

88.1

TAPE 2

kHz

MHz

2 1

Band indicators

Frequency display

Input selector display

Preset channel display

VIDEO 1, 2 indicator

TAPE 2 indicator

Operating instructions

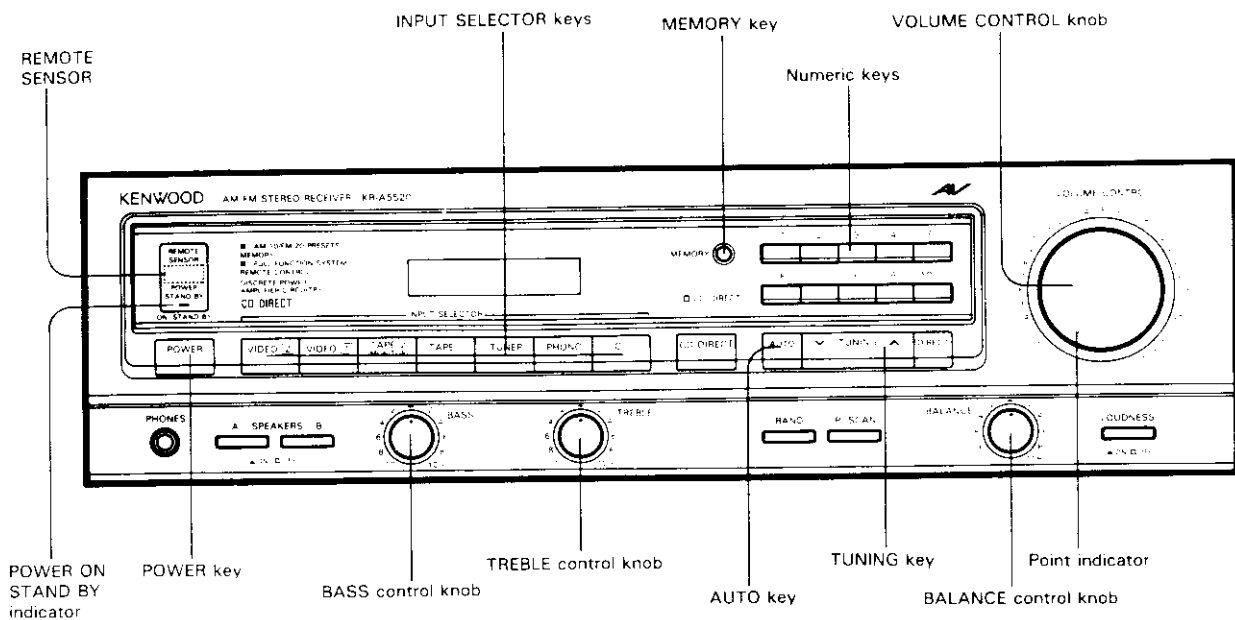

■ Basic operation

1. Press the **POWER** key to ON.
 - The display lights, the point indicator blinks for about 5 seconds then lights steadily, and the unit becomes operative.
 - Pressing the key again switches the power OFF.
2. Press one of the **INPUT SELECTOR** keys to select the input source to be played.
 - If a System Control cord has been connected to the selected source component, it starts play automatically due to the Automatic Play operation feature.
 - With the Automatic Play operation feature, when one of the source components is started to be played, the corresponding input selector is automatically switched for the source.
 - The selected input source is shown on the display.
3. If automatic play operation using the System control cords has not been set, start playing the source component selected.
4. Adjust the output level with the **VOLUME CONTROL** knob.
5. Adjust the balance of the left and right output levels with the **BALANCE** control knob.
6. Adjust the tone (**BASS**, **TREBLE**) for your preference.

Note:
When the **TAPE-2** selector switch is set to ON, the input source selected with the input selector keys cannot be heard from the speakers. To listen to a source other than tape deck 2, be sure to set the **TAPE-2** selector key to OFF.

■ Principal key function

TUNING key

Used to change the frequency.

AUTO key

Press this key to select the tuning mode between AUTO or manual. In manual mode, FM stereo broadcasts are received in monaural.

AUTO indicator ON → AUTO mode

AUTO indicator OFF → Manual mode

MEMORY key

This key is used to store the station frequency in memory.

Numeric (1 ~ 10/0) keys

Use these keys to:

- 1) input directly the digits of frequencies, or
- 2) store and recall frequencies in the preset channels.

Tone control knobs (BASS) (TREBLE)

Adjust tone controls to suit your taste.

BALANCE control knob

If an imbalance occurs (the left or right channel appears louder than the other) due to source imbalance or room acoustics, adjust **BALANCE** control to equalize the sound from both speakers.

LOUDNESS switch

If you customarily listen at low listening levels, set the **LOUDNESS** switch to ON. If not, set it to OFF position.

POWER STAND-BY indicator

This indicator lights if the power cord is plugged into the AC outlet. It is lit to show that the **POWER** switch on the front panel or the **POWER** key on the remote control unit can be activated.

REMOTE SENSOR

Point the supplied remote control unit towards this sensor and operate.

PHONES jack

This jack accepts the standard stereo headphone plug. When you wish to listen through headphones alone, set the **SPEAKERS** switches (A and B) both to the OFF (□) position.

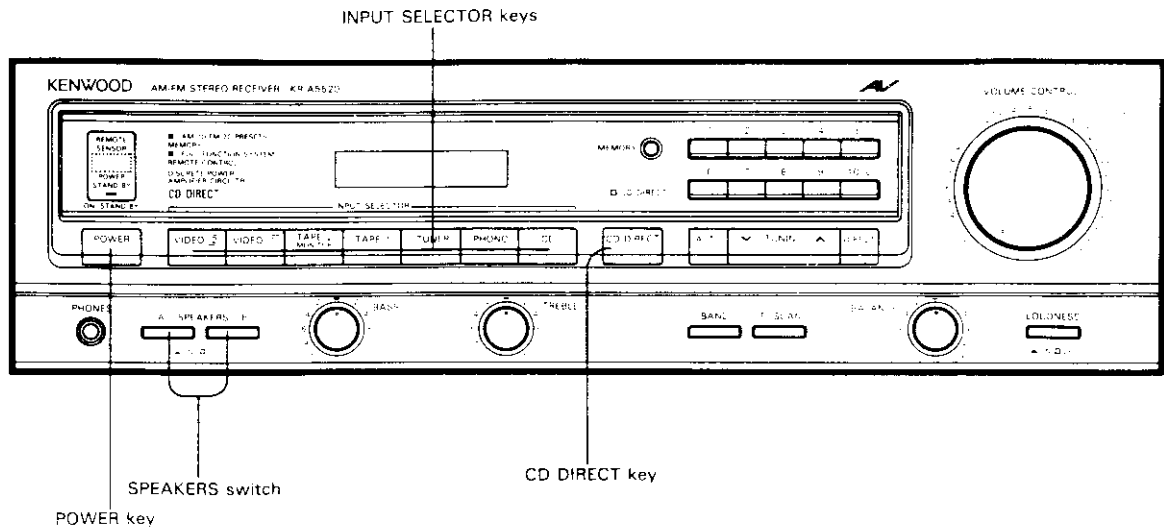

■ To record an input source

1. Press the **POWER** key to ON.
2. Select the source to be recorded with the **INPUT SELECTOR** keys.
3. Play the source.
4. Set tape deck 1 and/or tape deck 2 to record mode.

Note: _____
 When a tape deck is connected to this unit with a System Control cord, all of the input selector keys are disabled during recording and do not function until recording is finished. This will prevent the recording from being interrupted.

■ Operations using CD DIRECT key

To enjoy more pure and high-quality sound of Compact Discs:

1. Press the **CD** key.
2. Press the **CD DIRECT** key.
3. Play the **CD** player.
 - The **CD DIRECT** key is given priority over the setting of the input selector keys.
 - To cancel the **CD DIRECT** input, press the **CD DIRECT** key again or press one of the **INPUT SELECTOR** keys (except **CD** and **TAPE 2** keys). The input will be switched to the source indicated on the display.

■ Tape dubbing

Tape-recordings may be duplicated (dubbed) easily using two tape decks connected to the **TAPE 1** and **TAPE 2** jacks.

For example:

(**TAPE 1** to **2**):

1. Connect two tape decks to the **TAPE 1** and **TAPE 2** jacks.
2. Press the **TAPE 1** key.
3. Play back the recorded tape and adjust the recording levels before starting tape dubbing.

(**TAPE 2** to **1**):

1. Press the **TAPE 2** key.
2. Press a key other than **TAPE 1** of the **INPUT SELECTOR** keys such as **CD**.
3. Play back the recorded tape and adjust the recording levels before starting tape dubbing.
4. Do not press the **TAPE 1** key during recording with tape deck 1.

Note: _____
 Adjust recording levels on the deck that is making the copy using that deck's operating controls.

Listening to broadcasts

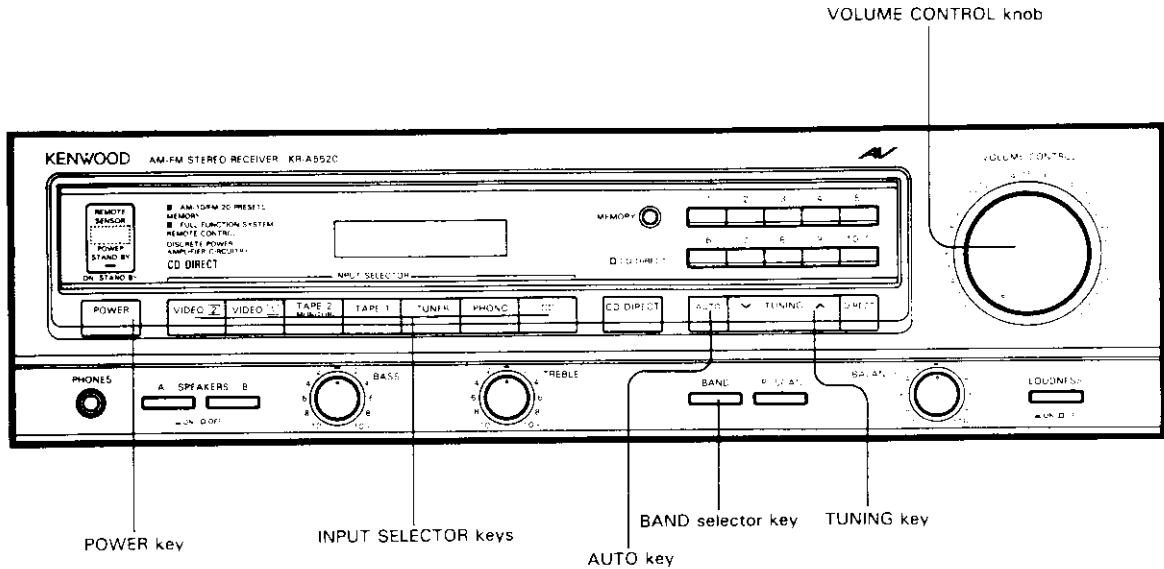

■ To listen to radio broadcasts

1. Press the **POWER** key to ON.
2. Press the **TUNER INPUT SELECTOR** key.
3. Press the **BAND selector key** to select **FM1**, **FM2** or **AM**.
 - Every time the BAND selector key is pressed, the receiving band is switched in order:

→ FM1 → FM2 → AM →

4. Tune in the desired broadcasting station according to the instructions in the "Tuning methods" section below.
 - During tuning, sound is not heard because the muting circuit is activated. The sound will be heard suddenly as soon as a station is received, so be careful in setting the sound volume level.
5. When the desired station is received, adjust the volume with the **VOLUME CONTROL** knob.

■ Tuning methods

Auto tuning

When the TUNING key is pressed, broadcast frequencies are scanned automatically in the upward or downward direction until a station is located and tuned in. The stereo/monaural FM reception mode is set automatically according to the station.

1. Press the **AUTO** key so that the **AUTO** indicator lights.
2. Press the **▲** (UP) or **▼** (DOWN) segment of the **TUNING** key.
 - Pressing the **▲** (UP) segment scans broadcast frequencies by varying the displayed frequencies in the upward direction, and pressing the **▼** (DOWN) segment scans by varying the frequencies in the downward direction.
 - When a broadcasting station is received, the frequency display freezes and indicates the frequency of the received station.
3. If the received station is not the desired station, press the same segment of the **TUNING** key again.
 - Repeat this until the desired station is received.

Manual tuning

Stations with weak signal strength cannot be received by auto tuning. In such cases, tune in the desired station by manual tuning. The station will be received in monaural mode (monaural mode is resistant to noise).

1. Press the **AUTO** key so that the **AUTO** indicator is off.
2. Press the **▲** (UP) or **▼** (DOWN) segment of the **TUNING** key.
 - Every time the TUNING key is pressed, the displayed frequency varies by one step in the direction indicated by the pressed segment.
 - Holding the TUNING key depressed varies the displayed frequency continuously.
3. When the frequency of the desired station is tuned in, release the **TUNING** key.
 - Noise may be heard if the tuned frequency is not precisely the same as the frequency of the station. In such cases, press the **▲** (UP) or **▼** (DOWN) segment of the TUNING key to adjust the tuning precisely.

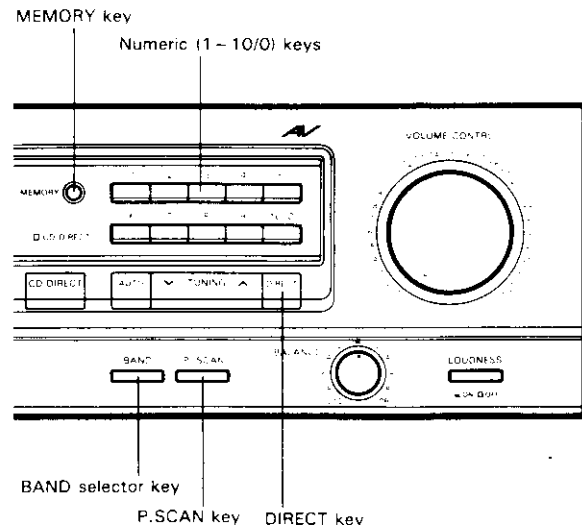
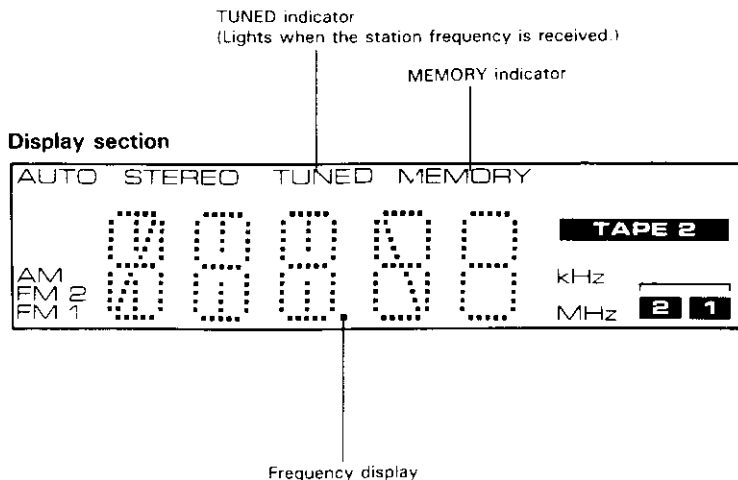

Direct tuning

This method allows the desired frequency to be entered directly using the numeric keys, without using the TUNING key.

1. Press the **DIRECT** key.
2. Enter the frequency of the desired station with the numeric keys.
 - When all of the digits of the frequency have been entered, the station is automatically received.
 - If the entered frequency is not in the receivable frequency range, the frequency display blinks for 5 seconds, and the last station received is received again.

■ Preset tuning

By storing the frequencies of broadcasting stations in the preset channels according to the instructions in the "To preset station frequencies" section, any of the preset stations can be received by one-touch operation.

Press the numeric key corresponding to the preset channel of the desired station.

- The display shows the frequency of that station, and the station is received.

■ To preset station frequencies

1. Press the **BAND selector key** for the desired band (**FM1**, **FM2** or **AM**).
2. Tune in the desired station following the instructions in the "Tuning methods" section.
3. Press the **MEMORY** key.
 - The **MEMORY** indicator on the display lights.
4. **Within 5 seconds after pressing the MEMORY key, press the numeric key (1 to 10/0) corresponding to the preset channel in which the frequency is to be stored.**
 - If a frequency has already been stored under the selected preset channel, the previously-stored frequency will be replaced by the new frequency.
5. **Preset all desired frequencies by repeating steps 1 to 4 above.**

■ Preset Scan

This function allows the preset stations stored in the preset channels to be received in sequence for 5 seconds each.

1. Press the **P.SCAN** key.
 - The frequency of each preset station is received for 5 seconds in sequence. A preset channel in which no station has been preset is skipped, and the scan operation moves to the next preset channel.
2. **To stop Preset Scan, press the P.SCAN key again.**
 - The preset station being received when the key is pressed is received continuously.

Remote control unit

■ Operations

1. **Connect the power plug of the receiver to an AC outlet.**
 - The receiver enters the power standby mode and the POWER/STANDBY indicator lights.
2. **Press the POWER key of the remote control unit or the POWER switch of the receiver.**
 - The receiver enters the power ON mode.
3. **The various functions of the receiver can be operated with the keys of the remote control unit.**

Note for remote control operation

After pressing one of the operation keys, when the next operation is required, press the next operation key firmly after an approx. 1 second interval.
If the next operation key is pressed immediately after the previous key, misoperation may result.

■ Operating range of the remote control unit

The operating range of the remote control unit may differ according to temperature, humidity, or using conditions, however, it is defined approximately as shown in the figure below:

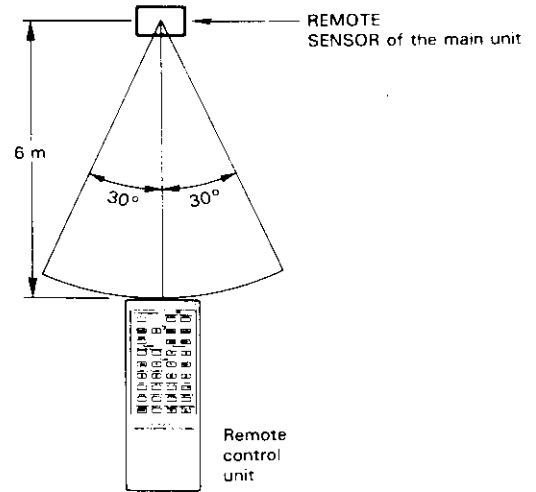

The signal transmission system used by this remote control unit is the infrared control system.

■ Installing the batteries in the remote control unit

1. **Remove the battery compartment cover.**

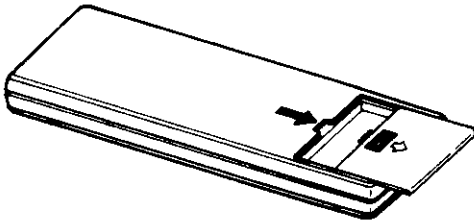

2. **Insert two size "AA" (R6) batteries confirming the correct polarity and close the cover in its place.**

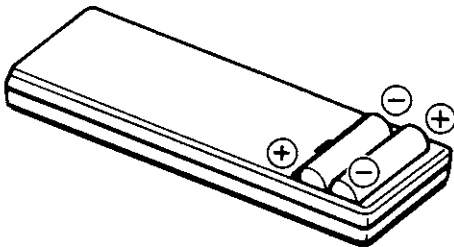

Note:

The provided batteries are to be used for checking the operation of the remote control unit, and they may have a short life. When the remote control unit becomes effective only for short distances or does not operate properly, replace the batteries with two new batteries.

Malfunction may occur in case direct sunlight or the light of a high-frequency lighting fluorescent lamp enters the remote control light receptor. In such a case, change the installation position of the unit so that the malfunction does not occur.

Caution in remote control

- In case any of the following models is used, the CD manual search cannot be operated from this remote control unit:
DP-M97, DP-57, DP-47
- If the CD player is not equipped with the System control jack, it cannot be operated properly from this remote control unit.
In such a case, please use the remote control unit provided with the CD player.

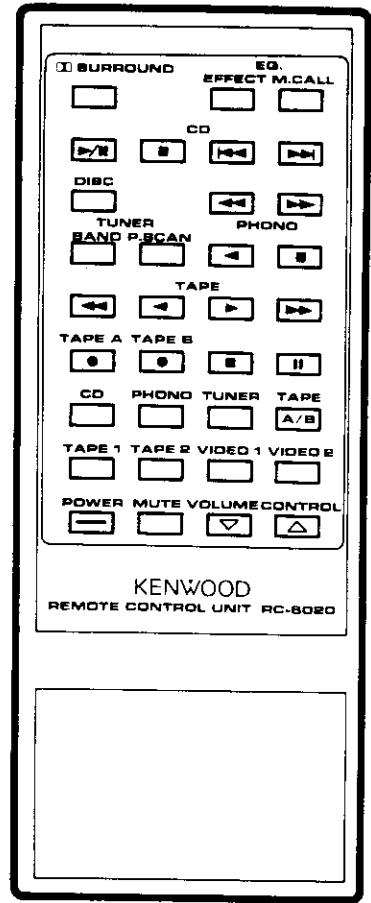

■ CD player control keys

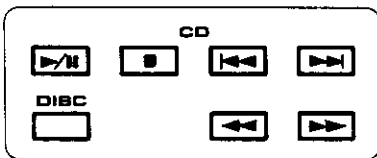

These keys allow the same operations as the keys with the same names on the CD player.

The DISC key is for use exclusively with a multiple CD player. Pressing the DISC key allows one of DISC 1 to DISC 6 to be selected in the following cycle.

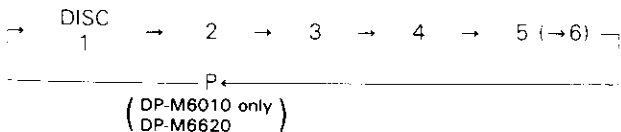

■ Equalizer/Surround key

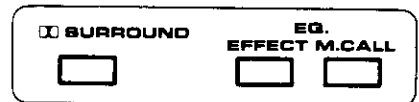

The EQ. keys allow the same operations as the keys with the Graphic equalizer.

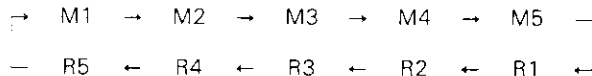

- Each press of the M.CALL key changes the contents as shown above.

The main body is not equipped with the Surround function. Therefore, the SURROUND key causes no effect even when it is pressed.

■ Turntable (PHONO) control keys



The play (◀) and Stop (■) keys are provided.

Remote control unit

■ Tuner control keys



These keys allow the same operations as the keys with the same names on the receiver.

■ Tape deck control keys

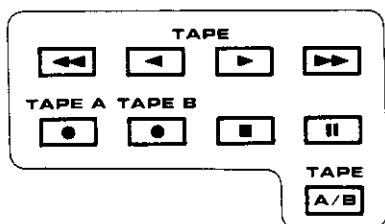

These keys allow the same operations as the keys with the same names on the tape deck A or B.

The KX-5010 and the KX-9010 (models only for Europe) can be remotely controlled by connecting with the system control cables.

When remote control cannot be performed even if the unit is connected with a system control cable, press the TAPE A/B switch and try it again.

Note:

When the Fast Forward key is to be pressed after the Rewind key was pressed, press the Stop key first, then press the Fast forward key .

■ Input selector keys

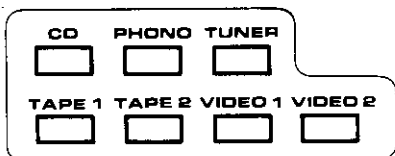

These keys have the same functions as the input selector keys on the receiver.

■ POWER key



Switches the power of the receiver to ON/STAND-BY (OFF).

■ Volume control keys



VOLUME CONTROL keys:

Pressing the key rotates the VOLUME CONTROL on the main body of the unit clockwise to increase the volume, and pressing the key rotates it counterclockwise to decrease the volume.

MUTE key:

The MUTE key is not provided on the main body. The muting can be controlled only from the remote control.

To mute the sound temporarily

Press the MUTE key on the remote control unit.

- The point indicator on the VOLUME CONTROL knob blinks, and the output sound is muted.
- The muting is canceled when the MUTE key is pressed again or the VOLUME or key is pressed.
- When the muting is canceled, the point indicator on the VOLUME CONTROL knob stops blinking and starts to light steadily.

System control operation

Connection

Using the system control cords provided with KENWOOD system component models, make connections as shown below.

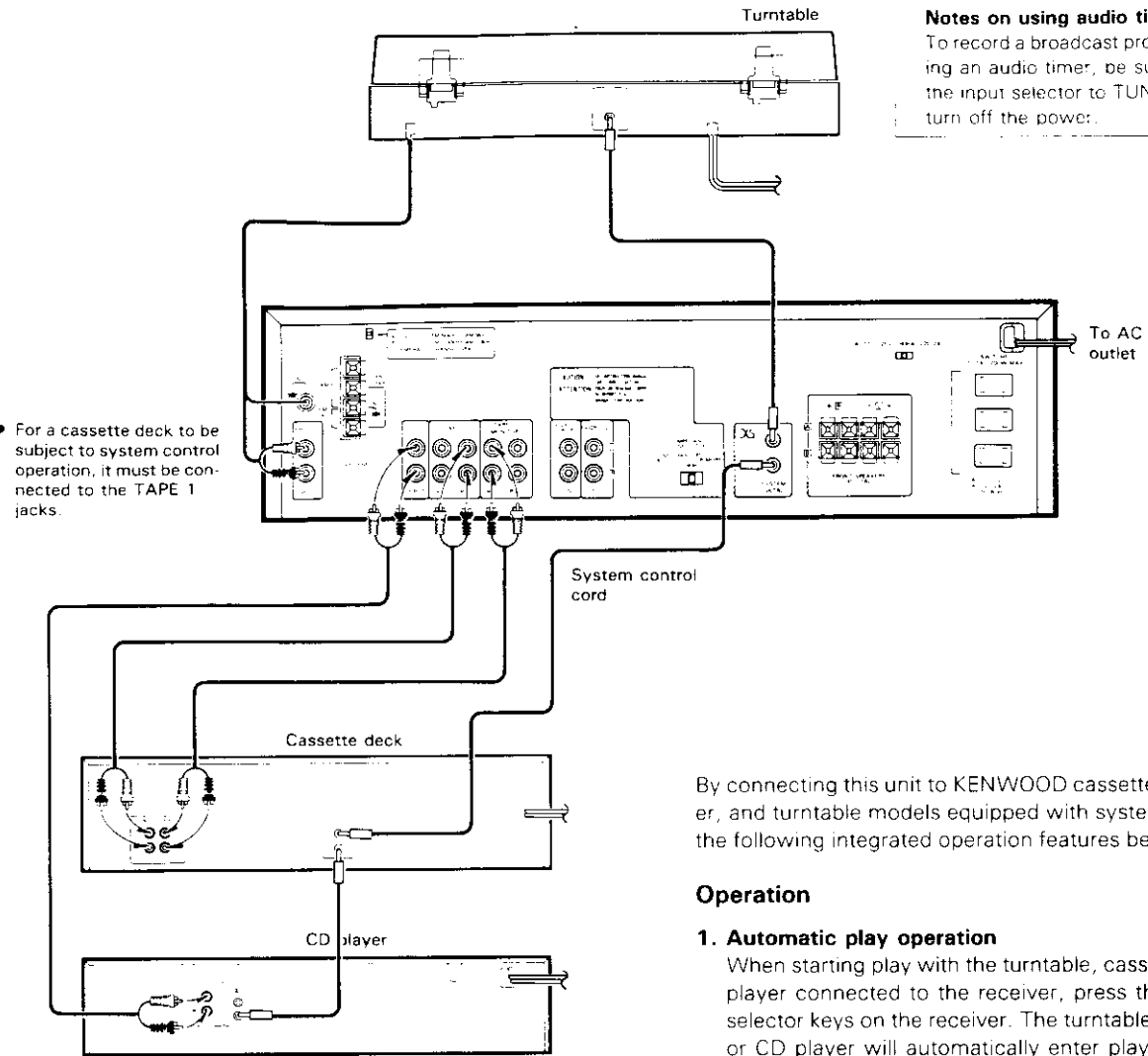

Notes on using audio timer

To record a broadcast program using an audio timer, be sure to set the input selector to TUNER, then turn off the power.

- For a cassette deck to be subject to system control operation, it must be connected to the TAPE 1 jacks.

By connecting this unit to KENWOOD cassette deck, CD player, and turntable models equipped with system control jacks, the following integrated operation features become available.

Operation

1. Automatic play operation

When starting play with the turntable, cassette deck, or CD player connected to the receiver, press the desired input selector keys on the receiver. The turntable, cassette deck, or CD player will automatically enter play mode.

In the same way, pressing the Play key of the turntable, cassette deck, or CD player will automatically switch the input selector on the receiver to the component on which the Play key is pressed.

2. Synchro recording

To record the sound from the CD player or turntable onto a tape with the cassette deck, press the CD or PHONO of the input selector switch and load a CD or record. Set the cassette deck to rec pause mode, then press the PLAY (START) key of the CD player or turntable. The cassette deck will start recording automatically, synchronized with the CD player or turntable starting play.

3. Remote control

The remote control unit provided with this unit, to which a KENWOOD system turntable, cassette deck, or CD player is connected, is equipped with related control keys. The related components can be controlled using these keys.

■ Connection of the audio cords and system control cord

Make sure that the audio cords are connected correctly right and left as in the figure.

If the system control cord and audio cords are not connected properly, the automatic system governing remote control and system functions will not operate.

(For connections of the audio cords, refer to the "System connections" diagram.)

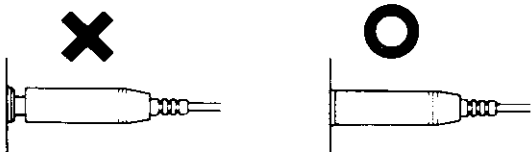

Note:

During recording with a cassette deck, the input selector on the receiver is fixed at the source from which the recording is made, by the system control circuit. At this time pressing any of the input selector keys has no effect.

In case of difficulty

If your unit should not perform as expected, consult the table below to see if the problem can be corrected before seeking help from your dealer or service representative.

Symptom	Cause	Remedy
No power, no sound.	<ul style="list-style-type: none"> ● Power cord not plugged in. ● Poor connection at wall outlet. Power outlet inactive. 	<ul style="list-style-type: none"> ● Check plug contact. ● Check outlet using a lamp or other appliance (outlet may be controlled by a wall switch).
No sound from left and right.	<ul style="list-style-type: none"> ● Speaker cords disconnected. ● Speakers switched off. 	<ul style="list-style-type: none"> ● Check speaker connections. ● Check speaker switch.
Sound from left or right, but not both.	<ul style="list-style-type: none"> ● Poor speaker connections. ● Defective speaker. 	<ul style="list-style-type: none"> ● Check connections at both ends of speaker cord. ● Reverse speakers, if problem stays with speaker, have speaker checked.
FM broadcast too noisy. Sufficient reception is impossible.	<ul style="list-style-type: none"> ● Indoor antenna is used. ● Poor connection of the antenna cable. 	<ul style="list-style-type: none"> ● Use an outdoor antenna. ● Connect the antenna cable correctly.
Dubbing from TAPE 2 to TAPE 1 is impossible.	<ul style="list-style-type: none"> ● The Input Selector TAPE 1 key is pressed. (The TAPE 1 indicator lights in the display.) 	<ul style="list-style-type: none"> ● Switch the input selector to a source other than TAPE 1.
No sound is heard with both of the SPEAKERS A and B switches set to ON.	<ul style="list-style-type: none"> ● A pair of speakers is not connected to one of the A or B speaker terminals. 	<ul style="list-style-type: none"> ● Connect two pairs of speakers correctly to both A and B speaker terminals. Or, switch the Speaker Selector to the A or B position to which the speakers are connected.
Remote control does not function.	<ul style="list-style-type: none"> ● Batteries are not loaded. Or batteries are exhausted. ● The remote sensor is obstructed. 	<ul style="list-style-type: none"> ● Replace the batteries with new ones. ● Remove the obstacle from in front of the remote sensor.
Occurs during AM reception only	Cause	Remedy
High-frequency whistle especially at night.	<ul style="list-style-type: none"> ● Interference from TV set. 	<ul style="list-style-type: none"> ● Turn off TV set. If problem disappears, try relocating TV set.
Intermittent buzz or cracking sound.	<ul style="list-style-type: none"> ● Lighting. ● Fluorescent lamps starting. ● Appliance or furnace starting. 	<ul style="list-style-type: none"> ● No remedy. ● Try reversing AC plug. ● Try reversing AC plug.
Occurs during FM reception only	Cause	Remedy
Hiss that gets worse in stereo reception.	<ul style="list-style-type: none"> ● Very weak antenna input signal. 	<ul style="list-style-type: none"> ● Consider an outdoor antenna installation. In areas remote from the transmitter, a 5 to 8 element antenna designed exclusively for FM is suggested.
Phythmic static or popping noises.	<ul style="list-style-type: none"> ● Automobile ignition noise, especially evident when receiving weak signals. 	<ul style="list-style-type: none"> ● Review antenna installation. Site the antenna as far from the street as possible and use coaxial cable.
STEREO indicator fails to light during stereo broadcast.	<ul style="list-style-type: none"> ● Another possible effect of a very weak signal. 	<ul style="list-style-type: none"> ● Antenna system needs attention (See above).

- Note:**
- As this system uses microcomputers, it is open to interference from external noise, and may sometimes not function properly. In such a case, unplug the power cord once, and then plug it in again.
 - Do not use contact cleaner because it could cause a malfunction. Be specially careful against contact cleaners containing oil, for they may deform the plastic components.

For the U.S.A.

FCC WARNING:

This equipment may generate or use radio frequency energy. Changes or modifications to this equipment may cause harmful interference unless the modifications are expressly approved in the instruction manual. The user could lose the authority to operate this equipment if an unauthorized change or modification is made.

Specifications

AUDIO SECTION

Rated Power Output (Except for Europe)

100 watts per channel minimum RMS, both channels driven at 8 ohms, from 20 Hz 20,000 Hz with no more than 0.06% total harmonic distortion. (FTC)

Total Harmonic Distortion

(1 kHz 8 ohms) 0.01% at 100 W

Input Sensitivity/Impedance

PHONO (MM) 2.5 mV/47 kohms

CD, TAPE, VIDEO 150 mV/47 kohms

Frequency Response

CD 10 Hz ~ 50 kHz $\begin{matrix} +0 \text{ dB} \\ -3 \text{ dB} \end{matrix}$

Signal-to-Noise Ratio (IHF-A)

PHONO (MM) 81 dB for 5 mV (IHF-66)

CD, TAPE, VIDEO 100 dB

Tone Controls

BASS $\pm 10 \text{ dB}/100 \text{ Hz}$

TREBLE $\pm 10 \text{ dB}/10 \text{ kHz}$

FM TUNER SECTION

Tuning Frequency Range 87.5 MHz ~ 108 MHz

Antenna Impedance 300 ohms balanced & 75 ohms unbalanced

Sensitivity

IHF 10.8 dBf (0.95 μV)

Signal-to-Noise Ratio at 65dBf (IHF)

Mono 79 dB

Stereo 73 dB

Total Harmonic Distortion at 1,000 Hz

Mono 0.3%

Stereo 0.5%

Frequency Response 30 Hz ~ 15 kHz $\begin{matrix} -0.5 \text{ dB} \\ -2 \text{ dB} \end{matrix}$

Stereo Separation 45 dB at 1 kHz

AM TUNER SECTION

Tuning Range

530 kHz ~ 1,610 kHz

(with the AM tuning interval set at 10 kHz)

531 kHz ~ 1,602 kHz

(with AM tuning interval set at 9 kHz)

Usable Sensitivity 12 μV (400 $\mu\text{V}/\text{m}$)

Signal-to-Noise Ratio 50 dB

Total Harmonic Distortion 0.5%

Selectivity 23 dB

GENERAL

Power Consumption 3.5 A USA and Canada Model/ 220 W... Others

Dimensions 440 (W) x 133 (H) x 350 (D) mm (17-5/16" x 5-1/4" x 13-3/4")

Weight (Net) 9.6 kg (21.1 lb)

Note:

KENWOOD follows a policy of continuous advancements in development. For this reason specifications may be changed without notice.

STAND BY mode of POWER key

When the power cord of this system is plugged into an AC outlet, the STAND BY indicator lights up regardless of the ON/OFF setting of the POWER key. This indicates that a small amount of current is being supplied to the unit to back up the memory contents. This mode is referred to as the Stand By mode. While the STAND BY indicator is lit, the power of the system can be switched ON/OFF from the remote control unit.

Strömbrytarens POWER beredskapsläge

Indikatorn STAND BY tänds efter nätkabelns anslutning till ett vägguttag, oavsett strömbrytarens POWER till/frånslag. Detta anger att en liten mängd ström leds till komponenten som stöd för minnesinnehållet. Detta läge kallas för beredskapsläget. Strömbrytaren på fjärrkontrollen kan användas för att slå på och av strömmen så länge indikatorn STAND BY lyser.

Virtanäppäimen (POWER) valmiustila (STAND BY)

Kun laitteen verkkojohto on liitetty pistorasiaan, valmiustilan merkkivalo syttyy riippumatta virtanäppäimen (POWER) asennosta (ON/OFF). Merkkivalo osoittaa, että laitteessa on hieman virtaa muistin sisältöjen ylläpitoa varten. Tätä tilaa kutsutaan valmiustilaksi. Kun valmiustilan merkkivalo (STAND BY) palaa, laitteen virta voidaan kytkeä ja katkaista kaukosäätimellä.

Afbrydertastens (POWER) STAND BY funktion

Når apparatets strømledning er tilsluttet en stikkontakt, lyser STAND BY indikatoren, uanset om der er tændt ved afbryderen på apparatet eller ej. Det angiver, at apparatet bliver forsynet med en ganske lille mængde strøm til opret-holdelse af hukommelsens indhold. Denne funktion kaldes STAND BY. Når STAND BY indikatoren er tændt, kan strømmen til apparatet slås til og fra med fjernstyrringsenheden.

PÅ/AV-knappens Stand-by funktion

Når strømledningen til dette anlegget er satt i en vekselstrømskontakt, vil STAND-BY indikatorlampen lyse enten PÅ/AV-knappen er på- eller avslått. Dette betyr at en viss mengde strøm tilføres anlegget slik at innholdet i minnet ikke går tapt. Denne funksjonen kalles Stand-by. Når indikatorlampen for STAND-BY er tent, kan strømmen slås PÅ/AV fra fjernkontrollen.